

**G.Cable
Center**





Global Cable Center Catalog

Professional Cable Installation Tools

Innovate, Lead and Globalize!



SCAN ME

Contact us now!  (+90) 543 578 7323  www.globalcablecenter.com

KABLO MAKARASI TAŞIMA RÖMORKLARI / CABLE DRUM TRAILER

3.000 Kg Kapasiteli Kablo Makarası Taşıma Römorku / 3.000 Kg Cable Drum Trailer

Teknik Özellikler / Technical Specifications

Ürün Kodu / Product code	: TBDKMR3000
Taşıma Kapasitesi / Capacity	: 3.000 Kg
Yüklü Ağırlık / Loaded Weight	: 3.750 kg
Azami Makara Çapı / Maximum Roller Diameter	: 1.100 mm - 2.500 mm
Yükleme Geniřliđi / Loading Width	: 1.600 mm
Azami Hız Sınırı / Maximum Speed Limit	: 80 km/h
Uzunluk / Length	: 3.000 mm
Geniřlik / Width	: 2.300 mm
Yükseklik / Height	: 1.700 mm

Standart Özellikler / Standard Features

- Hidrolik el pompası / hydraulic hand pump
- El freni / Handbrake
- Yükseklik ayarlı ön teker / Height adjustable front wheel
- Bağımsız çift taraflı lift sistemi / Independent double-sided lift system
- Yüksek mukavemetli çelik yapı / High strength steel structure
- Rulmanlı makara borusu / Bearing roller tube
- Makara kitleme sistemi / Roller locking system
- Güvenli kitleme sistemi / Safe locking system

Opsiyonel Özellikler / Optional Features

- Küçük makara raf adaptörü / Small reel rack adapter
- Motorlu yükleme boşaltma sistemi / Motorized loading and unloading system
- Makara Çevirme sistemi / reel turning system
- Süspansiyon sistemi / suspension system
- Havalı fren sistemi / air brake system
- Hidrolik fren sistemi / hydraulic brake system
- Araç elektrik aydınlatma sistemi / Vehicle electrical lighting system
- Kablo serme aparatı / cable laying apparatus



KABLO MAKARASI TAŞIMA RÖMORKLARI / CABLE DRUM TRAILER

5.000 Kg Kapasiteli Kablo Makarası Taşıma Römorku / 5.000 Kg Cable Drum Trailer

Teknik Özellikler / Technical Specifications

Ürün Kodu / Product code	: TBDKMR5000
Taşıma Kapasitesi / Capacity	: 5.000 Kg
Yüklü Ağırlık / Loaded Weight	: 5.900 kg
Azami Makara Çapı / Maximum Roller Diameter	: 1.100 mm - 2.600 mm
Yükleme Genişliği / Loading Width	: 1.600 mm
Azami Hız Sınırı / Maximum Speed Limit	: 80 km/h
Uzunluk / Length	: 3.100 mm
Genişlik / Width	: 2.300 mm
Yükseklik / Height	: 1.800 mm

Standart Özellikler / Standard Features

- Hidrolik el pompası / hydraulic hand pump
- El freni / Handbrake
- Yükseklik ayarlı ön teker / Height adjustable front wheel
- Bağımsız çift taraflı lift sistemi / Independent double-sided lift system
- Yüksek mukavemetli çelik yapı / High strength steel structure
- Rulmanlı makara borusu / Bearing roller tube
- Makara kitleme sistemi / Roller locking system
- Güvenli kitleme sistemi / Safe locking system

Opsiyonel Özellikler / Optional Features

- Küçük makara raf adaptörü / Small reel rack adapter
- Motorlu yükleme boşaltma sistemi / Motorized loading and unloading system
- Makara Çevirme sistemi / reel turning system
- Süspansiyon sistemi / suspension system
- Havalı fren sistemi / air brake system
- Hidrolik fren sistemi / hydraulic brake system
- Araç elektrik aydınlatma sistemi / Vehicle electrical lighting system
- Kablo serme aparatı / cable laying apparatus

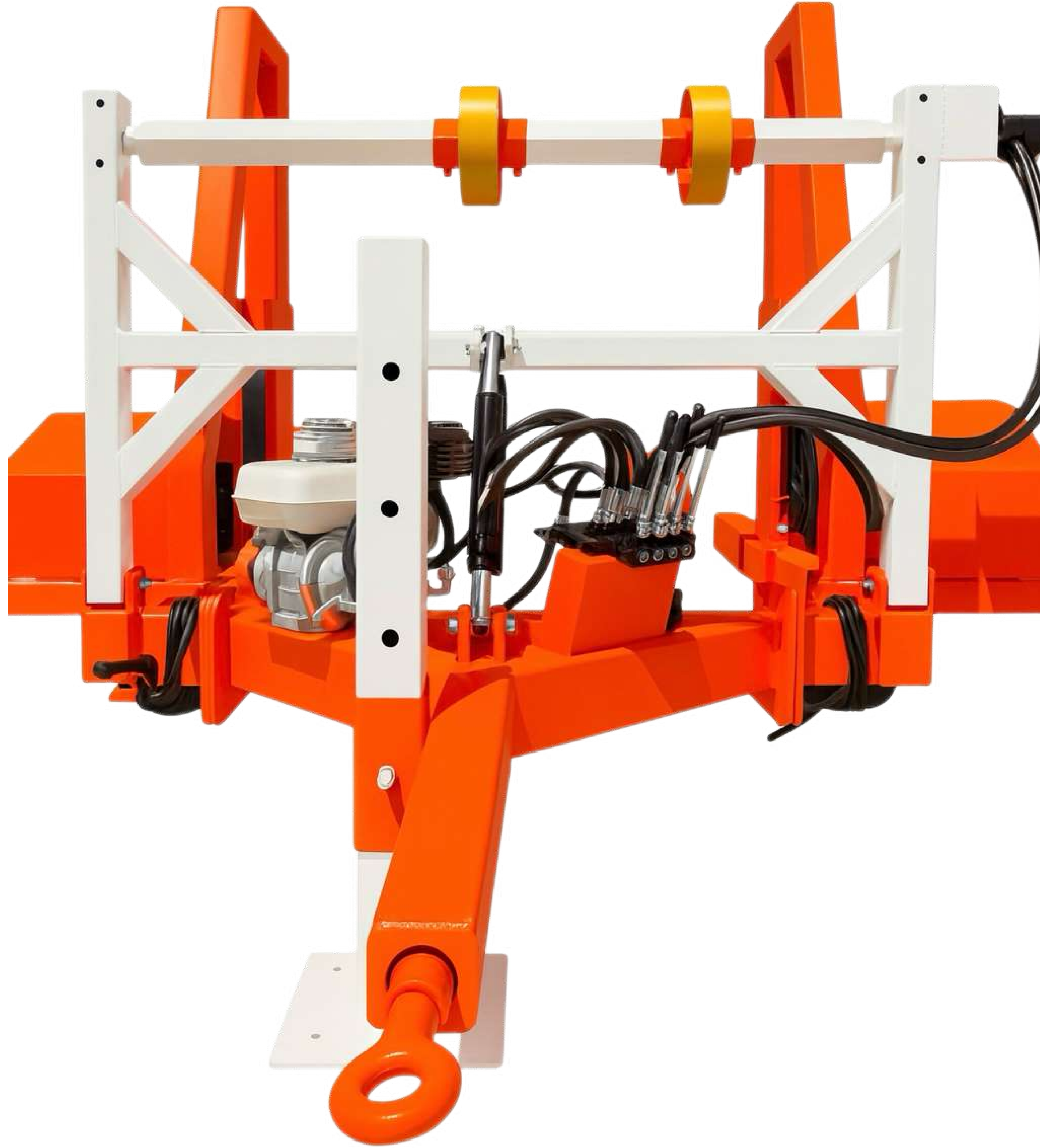

KABLO MAKARASI TAŞIMA RÖMORKLARI / CABLE DRUM TRAILER

8.000 Kg Kapasiteli Kablo Makarası Taşıma Römorku / 8.000 Kg Cable Drum Trailer

Teknik Özellikler / Technical Specifications

Ürün Kodu / Product code	: TBDKMR8000
Taşıma Kapasitesi / Capacity	: 8000 Kg
Yüklü Ağırlık / Loaded Weight	: 9000 kg
Azami Makara Çapı / Maximum Roller Diameter	: 1.100 mm - 2.800 mm
Yükleme Geniřliđi / Loading Width	: 1.800 mm
Azami Hız Sınırı / Maximum Speed Limit	: 80 km/h
Uzunluk / Length	: 3.300 mm
Geniřlik / Width	: 2.800 mm
Yükseklik / Height	: 1.800 mm

Standart Özellikler / Standard Features

- Hidrolik el pompası / hydraulic hand pump
- El freni / Handbrake
- Yükseklik ayarlı ön teker / Height adjustable front wheel
- Bağımsız çift taraflı lift sistemi / Independent double-sided lift system
- Yüksek mukavemetli çelik yapı / High strength steel structure
- Rulmanlı makara borusu / Bearing roller tube
- Makara kitleme sistemi / Roller locking system
- Güvenli kitleme sistemi / Safe locking system

Opsiyonel Özellikler / Optional Features

- Küçük makara raf adaptörü / Small reel rack adapter
- Motorlu yükleme boşaltma sistemi / Motorized loading and unloading system
- Makara Çevirme sistemi / reel turning system
- Süspansiyon sistemi / suspension system
- Havalı fren sistemi / air brake system
- Hidrolik fren sistemi / hydraulic brake system
- Araç elektrik aydınlatma sistemi / Vehicle electrical lighting system
- Kablo serme aparatı / cable laying apparatus
- Çift teker

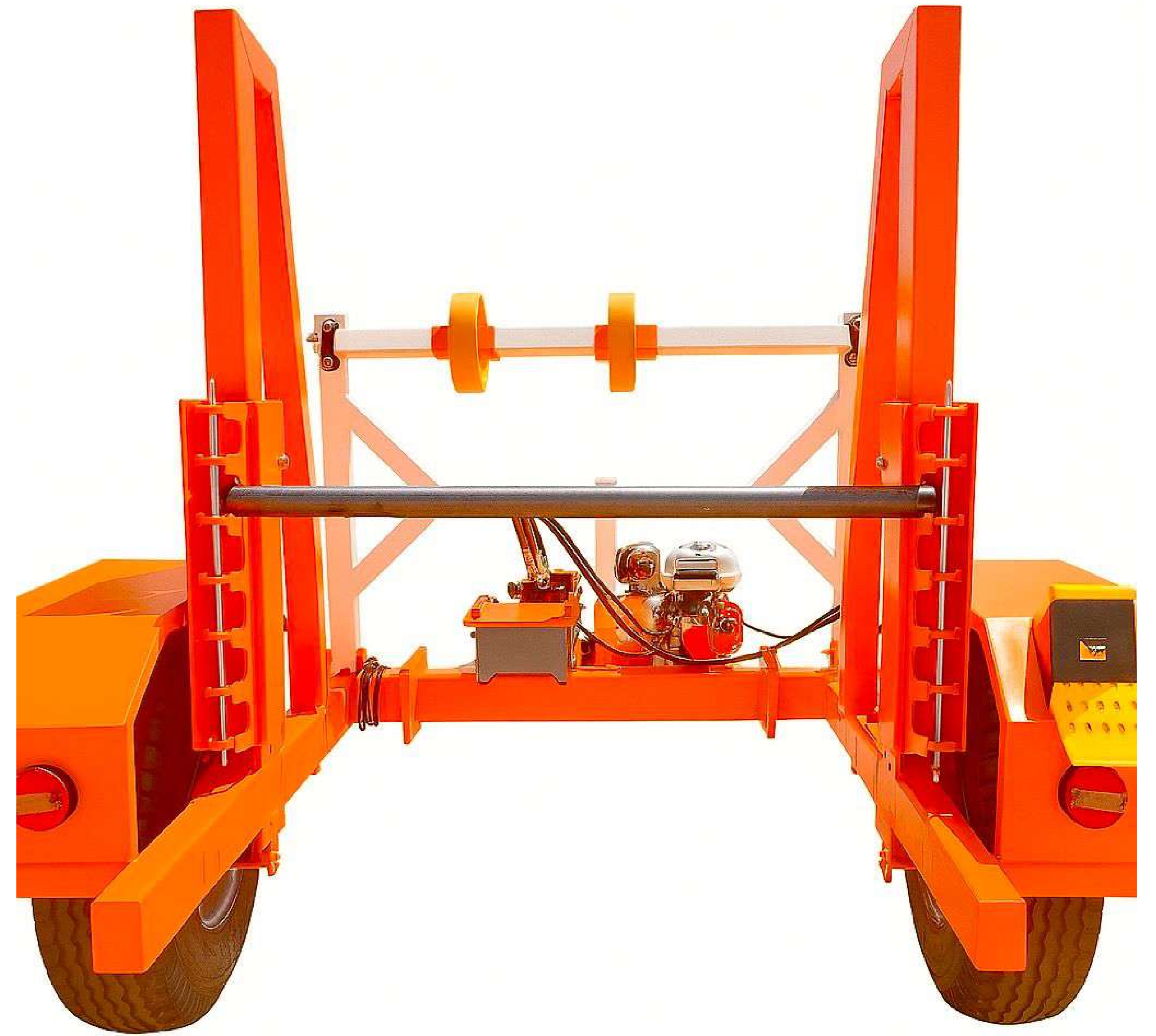
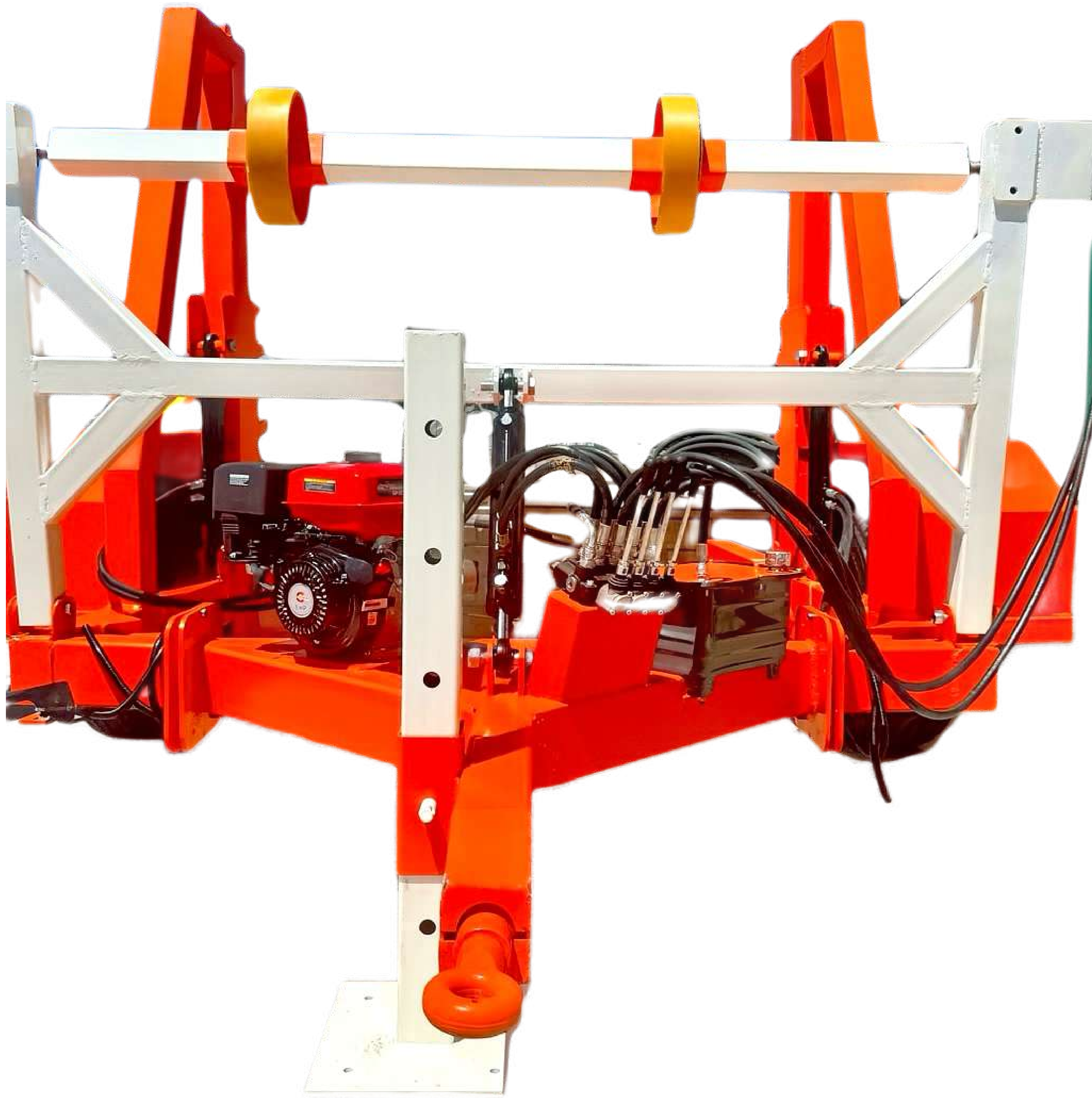

KABLO MAKARASI TAŞIMA RÖMORKLARI / CABLE DRUM TRAILER

10.000 Kg Kapasiteli Kablo Makarası Taşıma Römorku / 10.000 Kg Cable Drum Trailer

Teknik Özellikler / Technical Specifications

Ürün Kodu / Product code	: TBDKMR8000
Taşıma Kapasitesi / Capacity	: 10.000 Kg
Yüklü Ağırlık / Loaded Weight	: 11.200 kg
Azami Makara Çapı / Maximum Roller Diameter	: 1.100 mm - 3.000 mm
Yükleme Genişliği / Loading Width	: 2.000 mm
Azami Hız Sınırı / Maximum Speed Limit	: 80 km/h
Uzunluk / Length	: 3.600 mm
Genişlik / Width	: 3.200 mm
Yükseklik / Height	: 1.800 mm

Standart Özellikler / Standard Features

- Hidrolik el pompası / hydraulic hand pump
- El freni / Handbrake
- Yükseklik ayarlı ön teker / Height adjustable front wheel
- Bağımsız çift taraflı lift sistemi / Independent double-sided lift system
- Yüksek mukavemetli çelik yapı / High strength steel structure
- Rulmanlı makara borusu / Bearing roller tube
- Makara kitleme sistemi / Roller locking system
- Güvenli kitleme sistemi / Safe locking system

Opsiyonel Özellikler / Optional Features

- Küçük makara raf adaptörü / Small reel rack adapter
- Motorlu yükleme boşaltma sistemi / Motorized loading and unloading system
- Makara Çevirme sistemi / reel turning system
- Süspansiyon sistemi / suspension system
- Havalı fren sistemi / air brake system
- Hidrolik fren sistemi / hydraulic brake system
- Araç elektrik aydınlatma sistemi / Vehicle electrical lighting system
- Kablo serme aparatı / cable laying apparatus
- Çift teker



KABLO ÇEKME MAKİNASI / CABLE PULLING MACHİNA

1000 Kg Kapasiteli Kablo Çekme Makinası / 1000 Kg Capacity Cable Pulling Machina

Teknik Özellikler / Technical Specifications

Ürün Kodu / Product code	: TBDKC10
Çekme kapasitesi / Capacity	: 1.000 Kg
Çekme hızı / Pulling speed	: 15 mt / dk
Çalışma sistemi / Working system	: 220 W Elektrik - Electric
Uzunluk / Length	: 800 mm
Genişlik / Width	: 400 mm
Yükseklik / Height	: 350 mm
Ağırlık / Weight	: 75 Kg

Standart Özellikler / Standard Features

- Hız ayarı / Speed setting
- Ayak butonu / Foot button
- Çelik yapı / Steel structure
- Kolay kurulum / Easy setup

Opsiyonel Özellikler / Optional Features

- Taşıma arabası / Transport trolley
- Çekilen metrajı gösterme / Show footage shot



KABLO ÇEKME MAKİNASI / CABLE PULLING MACHİNA

2000 Kg Kapasiteli Kablo Çekme Makinası / 2000 Kg Capacity Cable Pulling Machina

Teknik Özellikler / Technical Specifications

Ürün Kodu / Product code	: TBDKC20
Çekme kapasitesi / Capacity	: 2.000 Kg
Çekme hızı / Pulling speed	: 15 mt / dk
Çalışma sistemi / Working system	: 220 W Elektrik - Electric
Uzunluk / Length	: 1000 mm
Genişlik / Width	: 400 mm
Yükseklik / Height	: 350 mm
Ağırlık / Weight	: 90 Kg

Standart Özellikler / Standard Features

- Hız ayarı / Speed setting
- Ayak butonu / Foot button
- Çelik yapı / Steel structure
- Kolay kurulum / Easy setup

Opsiyonel Özellikler / Optional Features

- Taşıma arabası / Transport trolley
- Çekilen metrajı gösterme / Show footage shot



KABLO ÇEKME MAKİNASI / CABLE PULLING MACHİNA

3000 Kg Kapasiteli Kablo Çekme Makinası / 3000 Kg Capacity Cable Pulling Machina

Teknik Özellikler / Technical Specifications

Ürün Kodu / Product code	: TBDKC30
Çekme kapasitesi / Capacity	: 3.000 Kg
Çekme hızı / Pulling speed	: 15 mt / dk
Çalışma sistemi / Working system	: 220 W Elektrik - Electric
Uzunluk / Length	: 1200 mm
Genişlik / Width	: 450 mm
Yükseklik / Height	: 380 mm
Ağırlık / Weight	: 95 Kg

Standart Özellikler / Standard Features

- Hız ayarı / Speed setting
- Ayak butonu / Foot button
- Çelik yapı / Steel structure
- Kolay kurulum / Easy setup

Opsiyonel Özellikler / Optional Features

- Taşıma arabası / Transport trolley
- Çekilen metrajı gösterme / Show footage shot

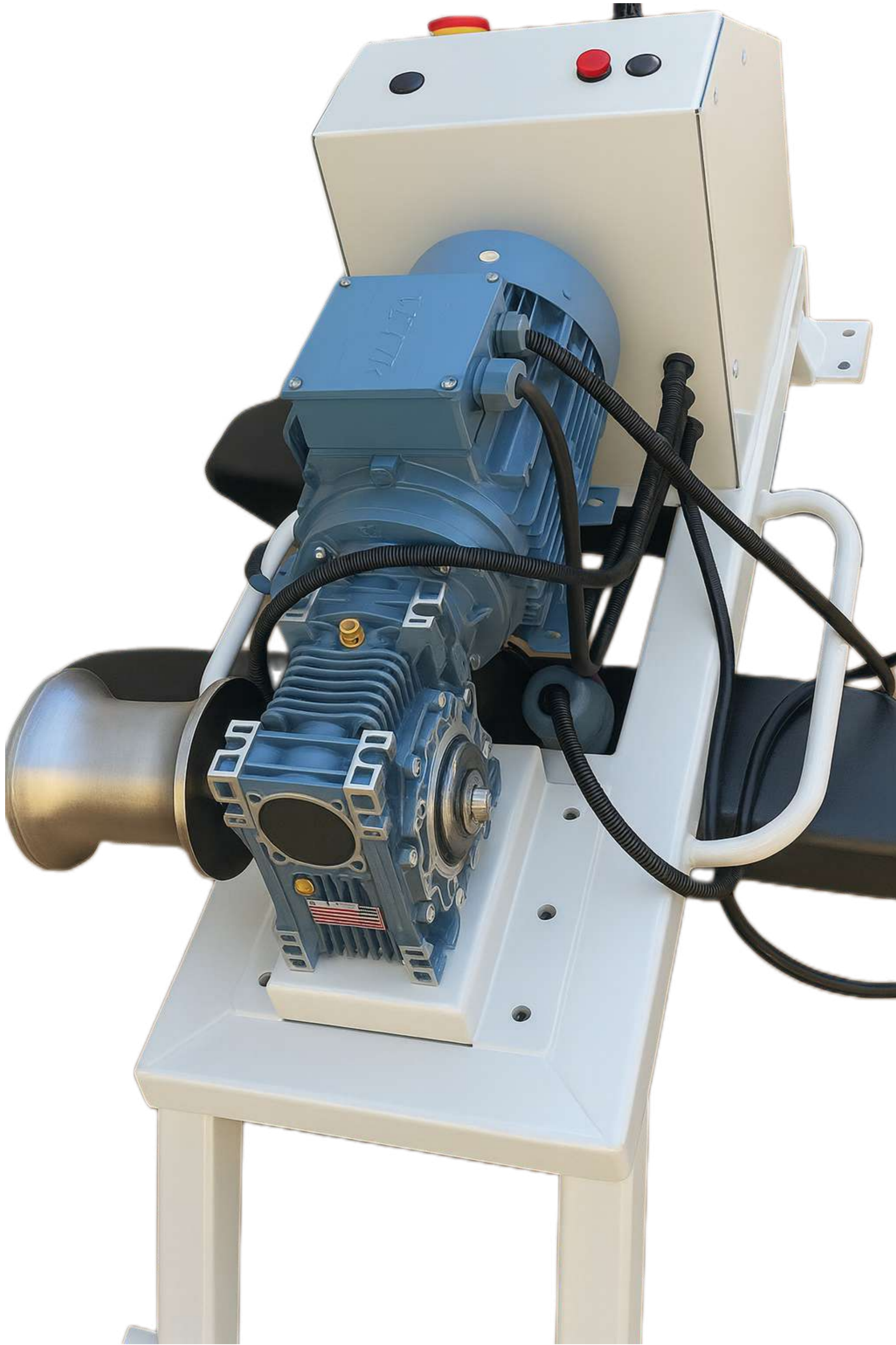

KABLO ÇEKME MAKİNASI / CABLE PULLING MACHİNA

3000 Kg Kapasiteli Kablo Çekme Makinası / 3000 Kg Capacity Cable Pulling Machina

Teknik Özellikler / Technical Specifications

Ürün Kodu / Product code	: TBDKC30B
Çekme kapasitesi / Capacity	: 3.000 Kg
Çekme hızı / Pulling speed	: 15 mt / dk
Halat çapı	: 8 mm
Halat boyu	: 200 mt
Çalışma sistemi / Working system	: 220 W Elektrik - Electric
Uzunluk / Length	: 500 mm
Genişlik / Width	: 1100 mm
Yükseklik / Height	: 380 mm
Ağırlık / Weight	: 100 Kg

Standart Özellikler / Standard Features

- Hız ayarı / Speed setting
- Ayak butonu / Foot button
- Çelik yapı / Steel structure
- Kolay kurulum / Easy setup

Opsiyonel Özellikler / Optional Features

- Taşıma arabası / Transport trolley
- Çekilen metrajı gösterme / Show footage shot



KABLO ÇEKME MAKİNASI / CABLE PULLING MACHINE

5000 Kg Kapasiteli Hidrolik Kablo Çekme Makinası / 5000 Kg Capacity Hydraulic Cable Pulling Machine Capsten

Teknik Özellikler / Technical Specifications

Ürün Kodu / Product code	: TBDKC50
Çekme kapasitesi / Capacity	: 5.000 Kg
Çekme hızı / Pulling speed	: 40 mt / dk
Çalışma sistemi / Working system	: Hidrolik - Hydraulic
Halat çapı / Rope diameter	: 12 mm
Halat uzunluğu / Rope length	: 500 mt
Uzunluk / Length	: 4.700 mm
Genişlik / Width	: 2.000 mm
Yükseklik / Height	: 1.500 mm
Ağırlık / Weight	: 2.600 Kg

Standart Özellikler / Standard Features

- Çift sargı sistemi / Capsten
- Pielsi kontrol sistemi / Pielsi control system
- Kuvvet sınırlandırma / Force limitation
- Halatı düzenli sarma sistemi / Regular winding system
- Frenli ve süspansiyonlu yürüyen sistem / Walking system with brake and suspension
- Çelik yapı / Steel structure
- Kolay kurulum / Easy setup

Opsiyonel Özellikler / Optional Features

- Kabloluzaktan kumanda / Wired remote control
- Radio kontrol sistemi / Radio control system
- Veri ve rapor yazıcısı / Data and report printer



KABLO ÇEKME MAKİNASI / CABLE PULLING MACHINE

8000 Kg Kapasiteli Hidrolik Kablo Çekme Makinası / 8000 Kg Capacity Hydraulic Cable Pulling Machine Capsten

Teknik Özellikler / Technical Specifications

Ürün Kodu / Product code	: TBDKC50
Çekme kapasitesi / Capacity	: 8.000 Kg
Çekme hızı / Pulling speed	: 40 mt / dk
Çalışma sistemi / Working system	: Hidrolik - Hydraulic
Halat çapı / Rope diameter	: 12 mm
Halat uzunluğu / Rope length	: 500 mt
Uzunluk / Length	: 4.700 mm
Genişlik / Width	: 2.000 mm
Yükseklik / Height	: 1.500 mm
Ağırlık / Weight	: 2.600 Kg

Standart Özellikler / Standard Features

- Çift sargı sistemi / Capsten
- Pielsi kontrol sistemi / Pielsi control system
- Kuvvet sınırlandırma / Force limitation
- Halatı düzenli sarma sistemi / Regular winding system
- Frenli ve süspansiyonlu yürüyen sistem / Walking system with brake and suspension
- Çelik yapı / Steel structure
- Kolay kurulum / Easy setup

Opsiyonel Özellikler / Optional Features

- Kablolu uzaktan kumanda / Wired remote control
- Radio kontrol sistemi / Radio control system
- Veri ve rapor yazıcısı / Data and report printer



KABLO ÇEKME MAKİNASI / CABLE PULLING MACHINE

10.000 Kg Kapasiteli Hidrolik Kablo Çekme Makinası / 10.000 Kg Capacity Hydraulic Cable Pulling Machine Capsten

Teknik Özellikler / Technical Specifications

Ürün Kodu / Product code	: TBDKC100
Çekme kapasitesi / Capacity	: 10.000 Kg
Çekme hızı / Pulling speed	: 40 mt / dk
Çalışma sistemi / Working system	: Hidrolik - Hydraulic
Halat çapı / Rope diameter	: 14 mm
Halat uzunluğu / Rope length	: 500 mt
Uzunluk / Length	: 4.700 mm
Genişlik / Width	: 2.200 mm
Yükseklik / Height	: 1.500 mm
Ağırlık / Weight	: 3.200 Kg

Standart Özellikler / Standard Features

- Çift sargı sistemi / Capsten
- Pielsi kontrol sistemi / Pielsi control system
- Kuvvet sınırlandırma / Force limitation
- Halatı düzenli sarma sistemi / Regular winding system
- Frenli ve süspansiyonlu yürüyen sistem / Walking system with brake and suspension
- Çelik yapı / Steel structure
- Kolay kurulum / Easy setup

Opsiyonel Özellikler / Optional Features

- Kabloluzaktan kumanda / Wired remote control
- Radio kontrol sistemi / Radio control system
- Veri ve rapor yazıcısı / Data and report printer



KABLO İTME MAKİNASI / CABLE PUSHING MACHINE

500 Kg Kapasiteli Kablo İtme Makinası / 500 Kg Cable Pushing Machine

Teknik Özellikler / Technical Specifications

Ürün Kodu / Product code	: TBDKİ5
İtme kapasitesi / Thrust capacity	: 500 Kg
İtme hızı / Pulling speed	: 40 mt / dk
Çalışma sistemi / Working system	: Elektrik - Electric
Uzunluk / Length	: 600 mm
Genişlik / Width	: 250 mm
Yükseklik / Height	: 250 mm
Ağırlık / Weight	: 70 Kg

Standart Özellikler / Standard Features

- Polüretan silindirler / Polyurethane rollers
- Hız ayarlama bilme / Ability to adjust speed
- İleri geri hareket / Move back and forth



1000 Kg Kapasiteli Kablo İtme Makinası / 1000 Kg Cable Pushing Machine

Teknik Özellikler / Technical Specifications

Ürün Kodu / Product code	: TBDKİ10
İtme kapasitesi / Thrust capacity	: 1000 Kg
İtme hızı / Pulling speed	: 40 mt / dk
Çalışma sistemi / Working system	: Elektrik - Electric
Uzunluk / Length	: 800 mm
Genişlik / Width	: 400 mm
Yükseklik / Height	: 1000 mm
Ağırlık / Weight	: 200 Kg



KABLO MAKARASI KALDIRMA EKİPMANI / CABLE DRUM LIFTING

300 Kg Kapasiteli Kablo Açma Sehbası / 300 Kg Capacity Cable Opening Diaphragm

Teknik Özellikler / Technical Specifications

Ürün Kodu / Product code	: TBDKS30
Taşıma kapasitesi / Capacity	: 300 Kg
Silindir Çapı / Cylinder diameter	: 32 mm
Uzunluk / Length	: 400 mm
Genişlik / Width	: 400 mm
Yükseklik / Height	: 150 mm
Ağırlık / Weight	: 8 Kg



500 Kg Kapasiteli Kablo Açma Sehbası / 500 Kg Capacity Cable Opening Diaphragm

Teknik Özellikler / Technical Specifications

Ürün Kodu / Product code	: TBDKS50
Taşıma kapasitesi / Capacity	: 500 Kg
Uzunluk / Length	: 400 mm
Genişlik / Width	: 150 mm
Yükseklik / Height	: 150 mm
Ağırlık / Weight	: 12 Kg

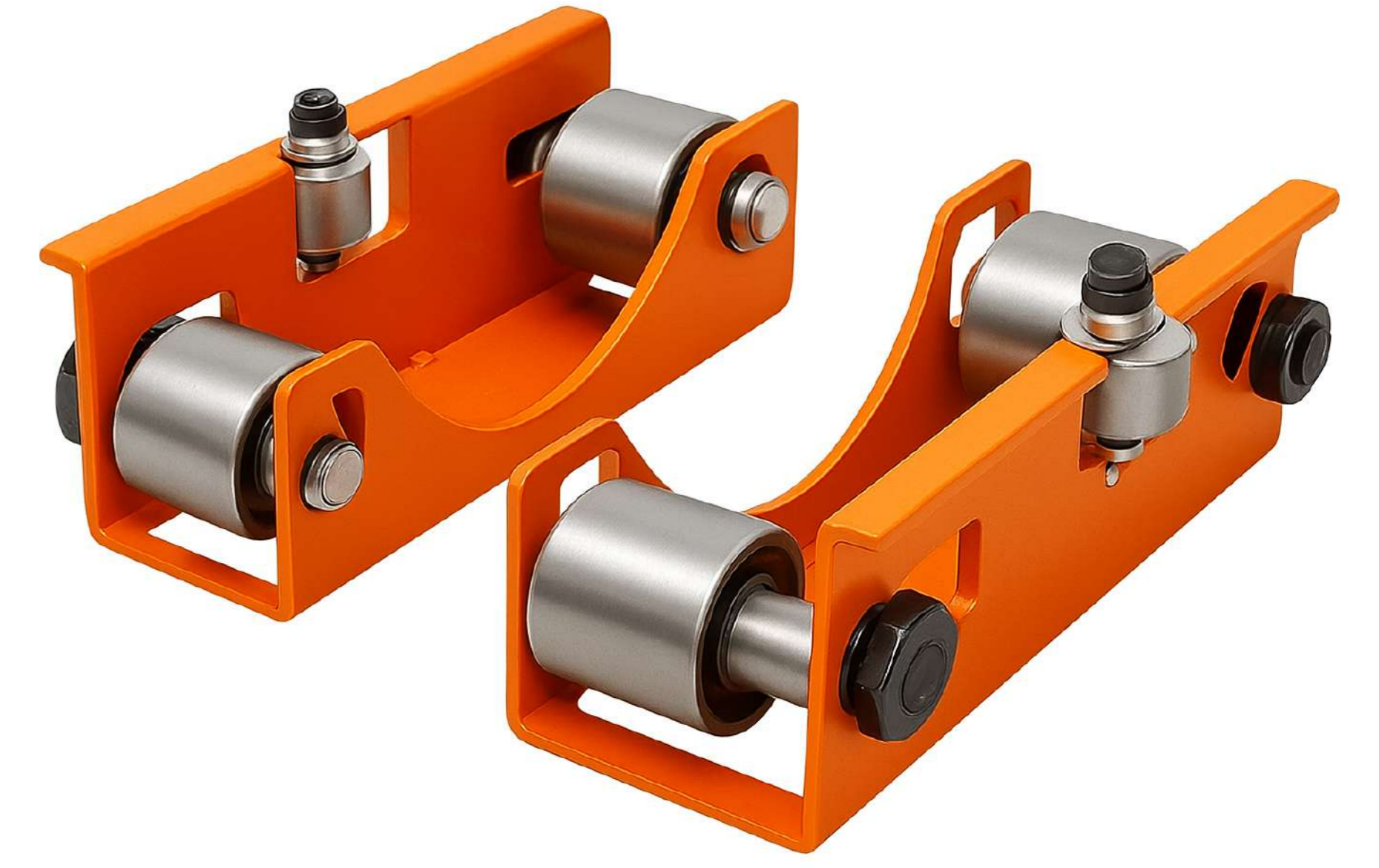

750 Kg Kapasiteli Kablo Açma Sehbası / 750 Kg Capacity Cable Opening Diaphragm

Teknik Özellikler / Technical Specifications

Ürün Kodu / Product code	: TBDKS75
Taşıma kapasitesi / Capacity	: 750 Kg
Silindir çapı / Cylinder diameter	: 42 mm
Uzunluk / Length	: 500 mm
Genişlik / Width	: 600 mm
Yükseklik / Height	: 150 mm
Ağırlık / Weight	: 15 Kg



1000 Kg Kapasiteli Kablo Açma Sehbası / 1000 Kg Capacity Cable Opening Diaphragm

Teknik Özellikler / Technical Specifications

Ürün Kodu / Product code	: TBDKS100
Taşıma kapasitesi / Capacity	: 1000 Kg
Uzunluk / Length	: 800 mm
Genişlik / Width	: 110 mm
Yükseklik / Height	: 150 mm
Ağırlık / Weight	: 30 Kg



KABLO MAKARASI KALDIRMA EKİPMANI / CABLE DRUM LIFTING

3000 Kg Kapasiteli Hidrolik Makara Kaldırma Ekipmanı / 3000 Kg Capacity Hydraulic Reel Lifting Equipment

Teknik Özellikler / Technical Specifications

Ürün Kodu / Product code	: TBDKS300H
Taşıma kapasitesi / Capacity	: 3000 Kg
Uygun makara çapları / Suitable reel diameters	: 600 mm - 2000 mm
Mil Çapı / Shaft diameter	: 60 mm
Mil uzunluğu / Shaft length	: 1500 mm
Çalışma sistemi / Working system	: Hidrolik / Hydraulic
Uzunluk / Length	: 400 mm
Genişlik / Width	: 300 mm
Yükseklik / Height	: 1050 mm
Ağırlık / Weight	: 90 Kg



5000 Kg Kapasiteli Hidrolik Makara Kaldırma Ekipmanı / 5000 Kg Capacity Hydraulic Reel Lifting Equipment

Teknik Özellikler / Technical Specifications

Ürün Kodu / Product code	: TBDKS500H
Taşıma kapasitesi / Capacity	: 5000 Kg
Uygun makara çapları / Suitable reel diameters	: 900 mm - 2200 mm
Mil Çapı / Shaft diameter	: 70 mm
Mil uzunluğu / Shaft length	: 1800 mm
Çalışma sistemi / Working system	: Hidrolik / Hydraulic
Uzunluk / Length	: 500 mm
Genişlik / Width	: 400 mm
Yükseklik / Height	: 1300 mm
Ağırlık / Weight	: 140 Kg



10.000 Kg Kapasiteli Hidrolik Makara Kaldırma Ekipmanı / 10.000 Kg Capacity Hydraulic Reel Lifting Equipment

Teknik Özellikler / Technical Specifications

Ürün Kodu / Product code	: TBDKS1000H
Taşıma kapasitesi / Capacity	: 10.000 Kg
Uygun makara çapları / Suitable reel diameters	: 1100 mm - 3400 mm
Mil Çapı / Shaft diameter	: 85 mm
Mil uzunluğu / Shaft length	: 2000 mm
Çalışma sistemi / Working system	: Hidrolik / Hydraulic
Uzunluk / Length	: 500 mm
Genişlik / Width	: 400 mm
Yükseklik / Height	: 1800 mm
Ağırlık / Weight	: 180 Kg



KABLO MAKARASI KALDIRMA EKİPMANI / CABLE DRUM LIFTING

3000 Kg Kapasiteli Makara Kaldırma Krişi / 3000 Kg Capacity Reel Lifting Jib

Teknik Özellikler / Technical Specifications

Ürün Kodu / Product code	: TBDMK30
Taşıma kapasitesi / Capacity	: 3000 Kg
Maximum makara genişliği / Maximum reel width	: 1400 mm
Uzunluk / Length	: 1400 mm
Genişlik / Width	: 120 mm
Yükseklik / Height	: 150 mm
Ağırlık / Weight	: 40 Kg



5000 Kg Kapasiteli Makara Kaldırma Krişi / 5000 Kg Capacity Reel Lifting Jib

Teknik Özellikler / Technical Specifications

Ürün Kodu / Product code	: TBDMK50
Taşıma kapasitesi / Capacity	: 5000 Kg
Maximum makara genişliği / Maximum reel width	: 1800 mm
Uzunluk / Length	: 1800 mm
Genişlik / Width	: 120 mm
Yükseklik / Height	: 150 mm
Ağırlık / Weight	: 70 Kg



6000 Kg Kapasiteli Makara Kaldırma Krişi / 6000 Kg Capacity Reel Lifting Jib

Teknik Özellikler / Technical Specifications

Ürün Kodu / Product code	: TBDMK60
Taşıma kapasitesi / Capacity	: 6000 Kg
Maximum makara genişliği / Maximum reel width	: 1800 mm
Uzunluk / Length	: 1800 mm
Genişlik / Width	: 150 mm
Yükseklik / Height	: 150 mm
Ağırlık / Weight	: 85 Kg

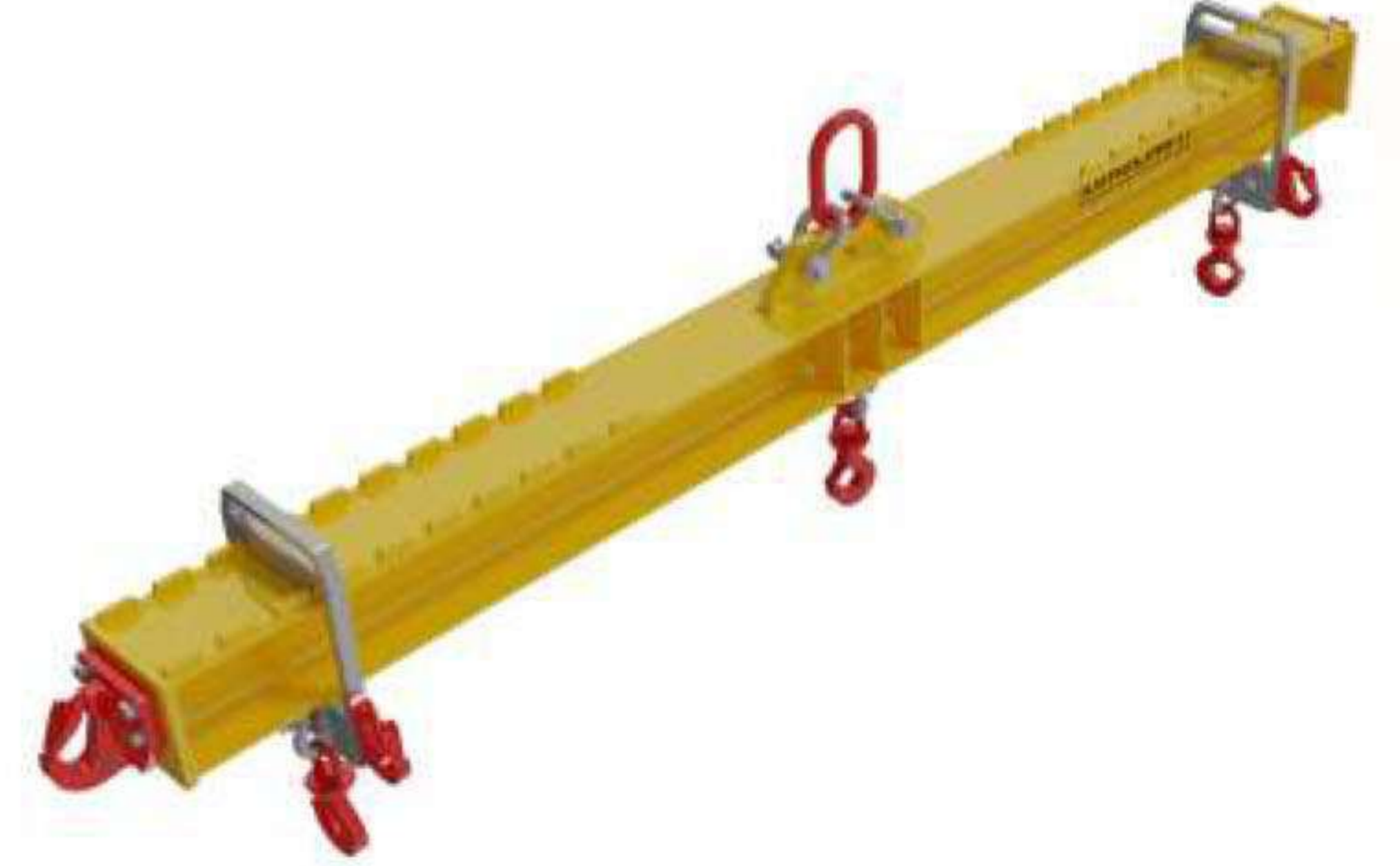

8000 Kg Kapasiteli Makara Kaldırma Krişi / 8000 Kg Capacity Reel Lifting Jib

Teknik Özellikler / Technical Specifications

Ürün Kodu / Product code	: TBDMK80
Taşıma kapasitesi / Capacity	: 8000 Kg
Maximum makara genişliği / Maximum reel width	: 1800 mm
Maximum makara çapı / Maximum reel diameter	: 3000 mm
Uzunluk / Length	: 1800 mm
Genişlik / Width	: 150 mm
Yükseklik / Height	: 150 mm
Ağırlık / Weight	: 95 Kg

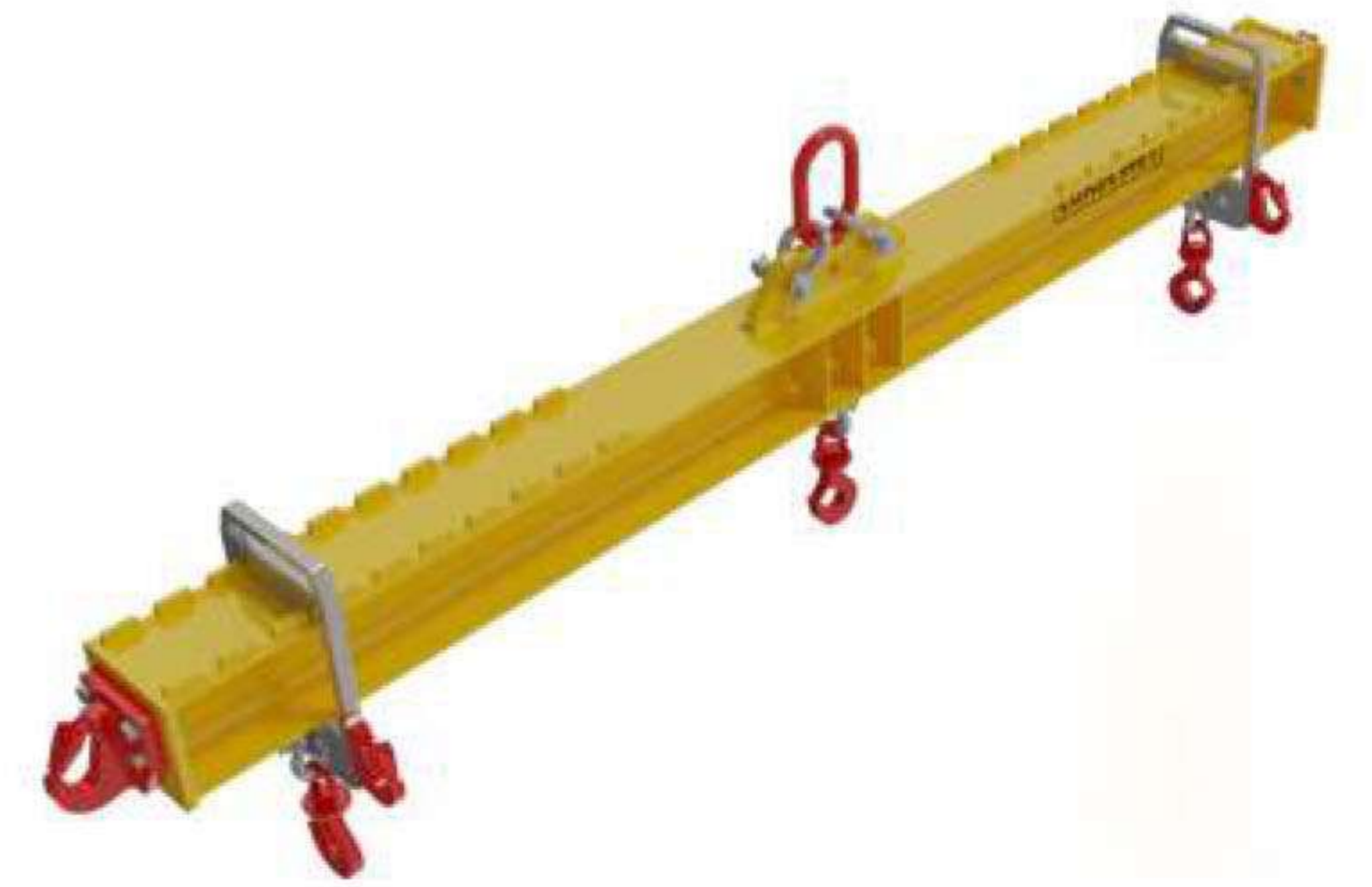

KABLO MAKARASI KALDIRMA EKİPMANI / CABLE DRUM LIFTING

10.000 Kg Kapasiteli Makara Kaldırma Krişi / 10.000 Kg Capacity Reel Lifting Jib

Teknik Özellikler / Technical Specifications

Ürün Kodu / Product code	: TBDMK100
Taşıma kapasitesi / Capacity	: 10.000 Kg
Maximum makara genişliği / Maximum reel width	: 2000 mm
Maximum makara çapı / Maximum reel diameter	: 3000 mm
Uzunluk / Length	: 2000 mm
Genişlik / Width	: 150 mm
Yükseklik / Height	: 150 mm
Ağırlık / Weight	: 110 Kg



12.000 Kg Kapasiteli Makara Kaldırma Krişi / 10.000 Kg Capacity Reel Lifting Jib

Teknik Özellikler / Technical Specifications

Ürün Kodu / Product code	: TBDMK120
Taşıma kapasitesi / Capacity	: 12.000 Kg
Maximum makara genişliği / Maximum reel width	: 2500 mm
Maximum makara çapı / Maximum reel diameter	: 3500 mm
Uzunluk / Length	: 2500 mm
Genişlik / Width	: 150 mm
Yükseklik / Height	: 200 mm
Ağırlık / Weight	: 130 Kg

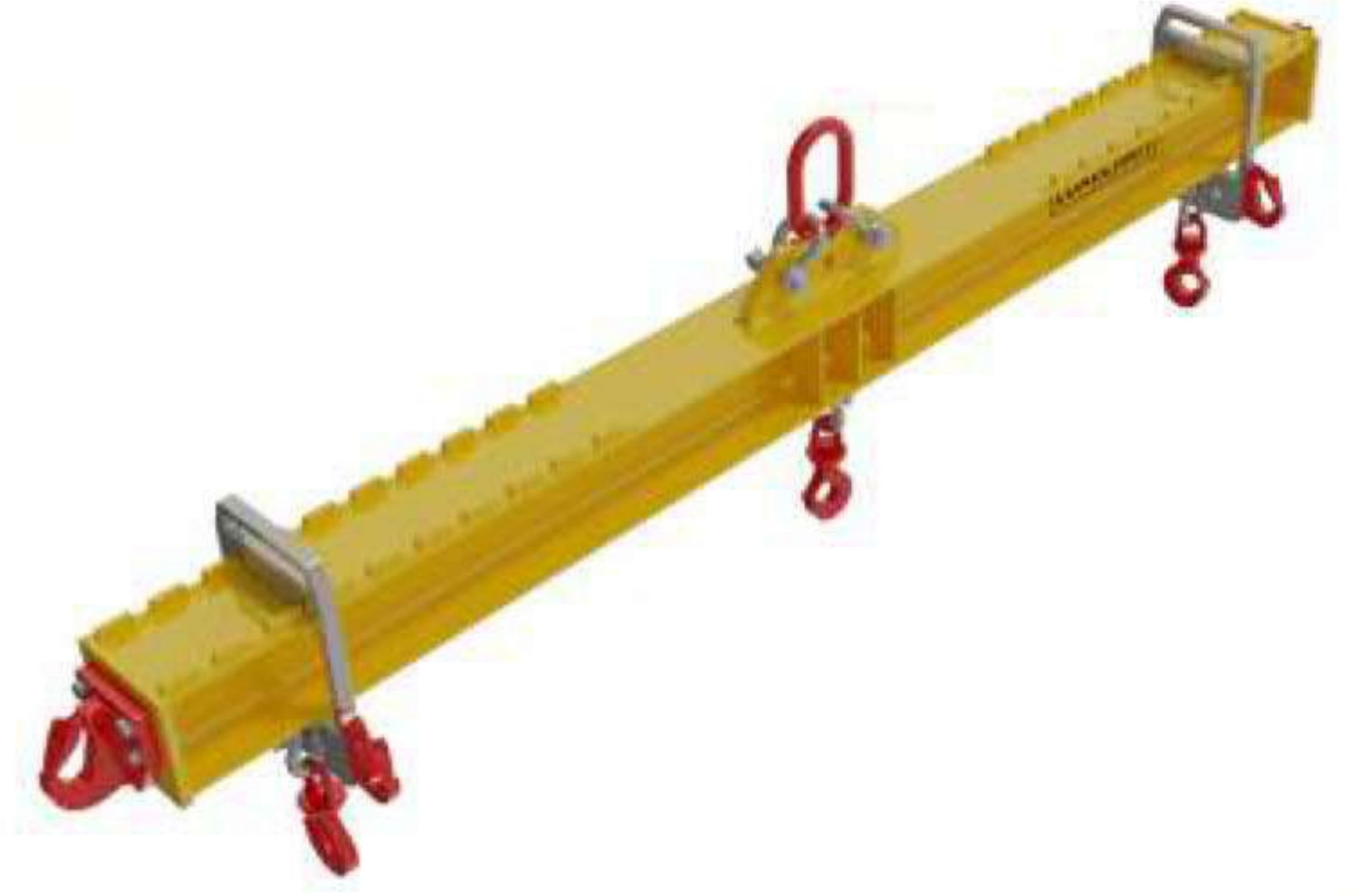

15.000 Kg Kapasiteli Makara Kaldırma Krişi / 15.000 Kg Capacity Reel Lifting Jib

Teknik Özellikler / Technical Specifications

Ürün Kodu / Product code	: TBDMK150
Taşıma kapasitesi / Capacity	: 15.000 Kg
Maximum makara genişliği / Maximum reel width	: 2500 mm
Maximum makara çapı / Maximum reel diameter	: 3500 mm
Uzunluk / Length	: 2500 mm
Genişlik / Width	: 150 mm
Yükseklik / Height	: 200 mm
Ağırlık / Weight	: 150 Kg



KABLO MAKARASI KALDIRMA EKİPMANI / CABLE DRUM LİFTİNG

Makara Hareket Milleri / Roller drive shafts

Rulmansız ve rulmanlı makara hareket millerimiz taşıyacağı ağırlıklara göre aşağıda belirtilmiştir.

Ürün kodu Product code	Taşıyacağı ağırlık Weight to carry	Çap Diameter	Uzunluk Length	Ağırlık Weight
TBDMHM20	2000 Kg	50 mm	1500 mm	24 Kg
TBDMHM30	3000 Kg	60 mm	1500 mm	34 Kg
TBDMHM30R	3000 Kg	60 mm	1500 mm	32 Kg
TBDMHM50	5000 Kg	75 mm	1800 mm	64 Kg
TBDMHM50R	5000 Kg	75 mm	1800 mm	60 Kg
TBDMHM80	8000 Kg	80 mm	2000 mm	81 Kg
TBDMHM80R	8000 Kg	80 mm	2000 mm	78 Kg
TBDMHM100	10.000 Kg	85 mm	2000 mm	91 Kg
TBDMHM100R	10.000 Kg	85 mm	2000 mm	87 Kg



Makara Sabitleme Kelepçeleri / Roller fixing clamps

Ürün Kodu / Product code	Çap / Diameter
TBDMHM20	50 mm
TBDMHM30	60 mm
TBDMHM50	75 mm
TBDMHM80	80 mm
TBDMHM100	85 mm



KABLO AÇMA YER MAKARALARI / CABLE ROLLER

Düz Tip Boru Ayaklı Kablo Açma Yer Makarası / Straight type tube foot cable release roller

Teknik Özellikler / Technical Specifications

Ürün Kodu / Product code	: TBDKA01
Taşıma kapasitesi / Capacity	: 750 Kg
Silindir Çapı / Cylinder diameter	: 76 mm
Uzunluk / Length	: 300 mm
Genişlik / Width	: 240 mm
Yükseklik / Height	: 220 mm
Ağırlık / Weight	: 5 Kg



Düz Tip Sac Ayaklı Kablo Açma Yer Makarası / Flat type cable release roller with sheet metal feet

Teknik Özellikler / Technical Specifications

Ürün Kodu / Product code	: TBDKAS01
Taşıma kapasitesi / Capacity	: 750 Kg
Silindir Çapı / Cylinder diameter	: 76 mm
Uzunluk / Length	: 300 mm
Genişlik / Width	: 240 mm
Yükseklik / Height	: 250 mm
Ağırlık / Weight	: 6 Kg



Düz Tip Oval Boru Ayaklı Kablo Açma Yer Makarası / Flat type oval tube foot cable roller

Teknik Özellikler / Technical Specifications

Ürün Kodu / Product code	: TBDKA02
Taşıma kapasitesi / Capacity	: 750 Kg
Silindir Çapı / Cylinder diameter	: 76 mm
Uzunluk / Length	: 400 mm
Genişlik / Width	: 240 mm
Yükseklik / Height	: 180 mm
Ağırlık / Weight	: 7,5 Kg



Oval Ayaklı Düz Tip Kablo Açma Yer Makarası / Flat type cable roller with round feet

Teknik Özellikler / Technical Specifications

Ürün Kodu / Product code	: TBDKA03
Taşıma kapasitesi / Capacity	: 750 Kg
Silindir Çapı / Cylinder diameter	: 76 mm
Uzunluk / Length	: 400 mm
Genişlik / Width	: 240 mm
Yükseklik / Height	: 220 mm
Ağırlık / Weight	: 7 Kg



KABLO AÇMA YER MAKARALARI / CABLE ROLLER

Köşe Tip Boru Ayaklı Kablo Açma Yer Makarası / Corner type tube foot cable release roller

Teknik Özellikler / Technical Specifications

Ürün Kodu / Product code	: TBDKAK01
Taşıma kapasitesi / Capacity	: 750 Kg
Silindir Çapı / Cylinder diameter	: 76 mm
Uzunluk / Length	: 250 mm
Genişlik / Width	: 300 mm
Yükseklik / Height	: 300 mm
Ağırlık / Weight	: 9 Kg



Köşe Tip Sac Ayaklı Kablo Açma Yer Makarası / Corner type cable release ground reel with sheet metal feet

Teknik Özellikler / Technical Specifications

Ürün Kodu / Product code	: TBDKAS01
Taşıma kapasitesi / Capacity	: 750 Kg
Silindir Çapı / Cylinder diameter	: 76 mm
Uzunluk / Length	: 300 mm
Genişlik / Width	: 240 mm
Yükseklik / Height	: 250 mm
Ağırlık / Weight	: 7 Kg



Köşe Tip Hareketli Kablo Açma Yer Makarası / Corner type e-cable release roller

Teknik Özellikler / Technical Specifications

Ürün Kodu / Product code	: TBDKAS02
Taşıma kapasitesi / Capacity	: 750 Kg
Silindir Çapı / Cylinder diameter	: 76 mm
Uzunluk / Length	: 300 mm
Genişlik / Width	: 240 mm
Yükseklik / Height	: 250 mm
Ağırlık / Weight	: 9,5 Kg



Yatay Köşe Dönüş Makarası 6 Konikli / Horizontal corner return roller with 6 cones

Teknik Özellikler / Technical Specifications

Ürün Kodu / Product code	: TBDKAK02
Taşıma kapasitesi / Capacity	: 750 Kg
Silindir Çapı / Cylinder diameter	: 76 mm
Uzunluk / Length	: 400 mm
Genişlik / Width	: 300 mm
Yükseklik / Height	: 220 mm
Ağırlık / Weight	: 16 Kg



KABLO AÇMA YER MAKARALARI / CABLE ROLLER

Yatay Köşe Dönüş Makarası 6 Konikli Kilitli / Horizontal Corner Roller 6 Conical Locked

Teknik Özellikler / Technical Specifications

Ürün Kodu / Product code	: TBDKAK03
Taşıma kapasitesi / Capacity	: 750 Kg
Silindir Çapı / Cylinder diameter	: 76 mm
Uzunluk / Length	: 400 mm
Genişlik / Width	: 400 mm
Yükseklik / Height	: 220 mm
Ağırlık / Weight	: 19 Kg



Yatay Köşe Dönüş Makarası 3 Konikli Krişli / Horizontal Corner Roller 3 Conical Beam

Teknik Özellikler / Technical Specifications

Ürün Kodu / Product code	: TBDKAK04
Taşıma kapasitesi / Capacity	: 750 Kg
Silindir Çapı / Cylinder diameter	: 76 mm
Uzunluk / Length	: 300 mm
Genişlik / Width	: 240 mm
Yükseklik / Height	: 800 mm
Ağırlık / Weight	: 22 Kg



Yatay Köşe Dönüş Makarası 3 Konikli Künk Agızlı / Horizontal Corner Roller 3 Conical With Groove Mouth

Teknik Özellikler / Technical Specifications

Ürün Kodu / Product code	: TBDKAK05
Taşıma kapasitesi / Capacity	: 750 Kg
Silindir Çapı / Cylinder diameter	: 76 mm
Uzunluk / Length	: 380 mm
Genişlik / Width	: 240 mm
Yükseklik / Height	: 800 mm
Ağırlık / Weight	: 24 Kg



Askılı Kablo Atlatma Makarası / Suspended Cable Jump Reel

Teknik Özellikler / Technical Specifications

Ürün Kodu / Product code	: TBDKAA01
Taşıma kapasitesi / Capacity	: 750 Kg
Silindir Çapı / Cylinder diameter	: 76 mm
Uzunluk / Length	: 1000 mm
Genişlik / Width	: 220 mm
Yükseklik / Height	: 1200 mm
Ağırlık / Weight	: 24 Kg



KABLO AÇMA YER MAKARALARI / CABLE ROLLER

Askılı Kablo Atlama Makarası Hareketli / Suspended Cable Jump Reel Movable

Teknik Özellikler / Technical Specifications

Ürün Kodu / Product code	: TBDKAA02
Taşıma kapasitesi / Capacity	: 750 Kg
Silindir Çapı / Cylinder diameter	: 76 mm
Uzunluk / Length	: 1000 mm
Genişlik / Width	: 220 mm
Yükseklik / Height	: 800 mm
Ağırlık / Weight	: 19 Kg



Makara Bağlantı Kirişi / Spool Connection Jack

Teknik Özellikler / Technical Specifications

Ürün Kodu Product code	Çap Diameter	Uzunluk Length	Ağırlık Weight
TBDKAMK01	60 mm	40-60 cm	6.20 Kg
TBDKAMK02	60 mm	60-100 cm	8.50 Kg
TBDKAMK03	60 mm	80-130 cm	10,00 Kg
TBDKAMK04	60 mm	100-170 cm	11.50 Kg
TBDKAMK05	60 mm	140-240 cm	15.50 Kg
TBDKAMK06	60 mm	170-300 cm	11.50 Kg



Makara Kilidi / Roller lock

Teknik Özellikler / Technical Specifications

Ürün Kodu / Product code	: TBDKAKL01
Uzunluk / Length	: 220 mm
Genişlik / Width	: 25 mm
Yükseklik / Height	: 220 mm
Ağırlık / Weight	: 1 Kg



Kablo Destek Makarası / Cable brace roller

Teknik Özellikler / Technical Specifications

Ürün Kodu / Product code	: TBDKAMK07
Uzunluk / Length	: 40-60 cm
Genişlik / Width	: 120 mm
Yükseklik / Height	: 120 mm
Ağırlık / Weight	: 6,20 Kg



KABLO AÇMA YER MAKARALARI / CABLE ROLLER

L Tipi Menhol Agzı Makara 3 Konikli / L Type Manhole Mouth Cable Opening Reel 3 Conical

Teknik Özellikler / Technical Specifications

Ürün Kodu / Product code	: TBDKAL01
Taşıma kapasitesi / Capacity	: 750 Kg
Silindir Çapı / Cylinder diameter	: 76 mm
Uzunluk / Length	: 400 mm
Genişlik / Width	: 220 mm
Yükseklik / Height	: 400 mm
Ağırlık / Weight	: 14 Kg

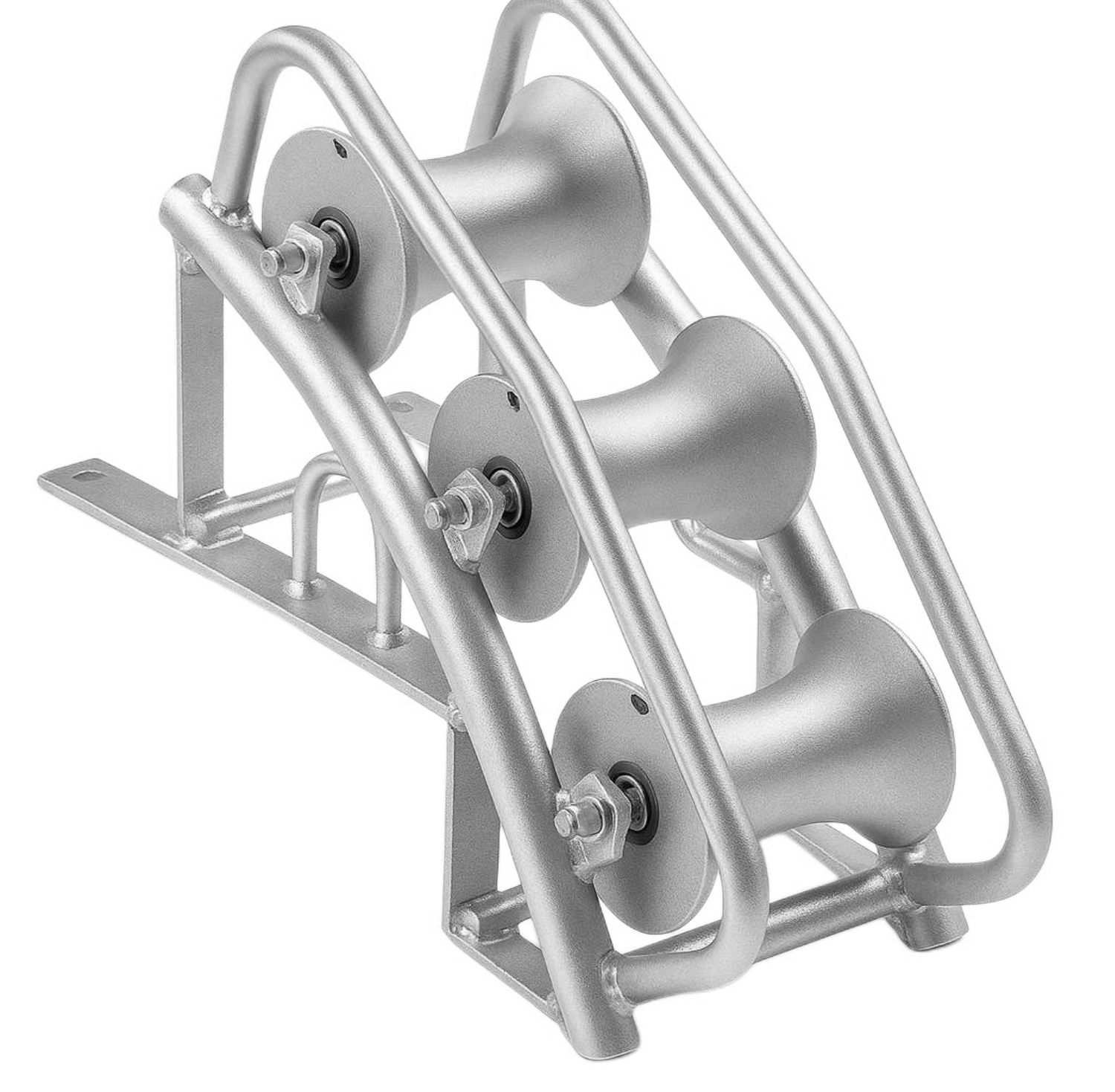

L Tipi Menhol Agzı Makara 4 Konikli / L Type Manhole Mouth Cable Opening Reel 4 Conical

Teknik Özellikler / Technical Specifications

Ürün Kodu / Product code	: TBDKAL02
Taşıma kapasitesi / Capacity	: 750 Kg
Silindir Çapı / Cylinder diameter	: 76 mm
Uzunluk / Length	: 600 mm
Genişlik / Width	: 220 mm
Yükseklik / Height	: 600 mm
Ağırlık / Weight	: 19 Kg

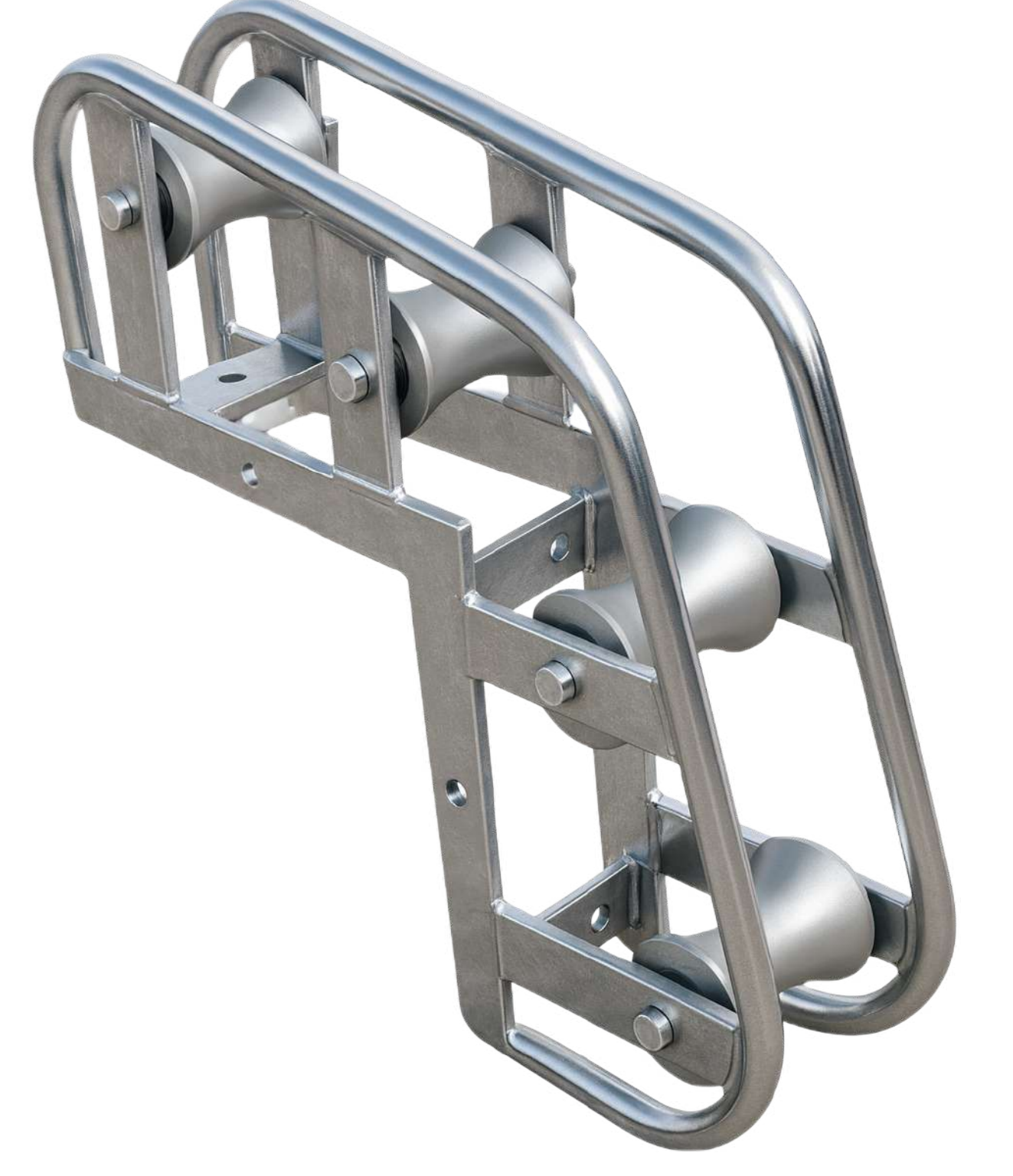

L Tipi Menhol Agzı Makara 6 Konikli / L Type Manhole Mouth Cable Opening Reel 6 Conical

Teknik Özellikler / Technical Specifications

Ürün Kodu / Product code	: TBDKAK05
Taşıma kapasitesi / Capacity	: 750 Kg
Silindir Çapı / Cylinder diameter	: 76 mm
Uzunluk / Length	: 750 mm
Genişlik / Width	: 220 mm
Yükseklik / Height	: 750 mm
Ağırlık / Weight	: 26 Kg



L Tipi Menhol Agzı Makara Künk Agzılı / L Type Manhole Mouth Spool Grooved Mouth

Teknik Özellikler / Technical Specifications

Ürün Kodu Product code	Çap Diameter	Ağırlık Weight
TBDKAKAL01	50 mm	1,50 Kg
TBDKAKAL02	80 mm	3,00 Kg
TBDKAKAL03	100 mm	4,00 Kg
TBDKAKAL04	120 mm	5,00 Kg
TBDKAKAL05	150 mm	7,00 Kg
TBDKAKAL06	200 mm	9,00 Kg



KABLO AÇMA YER MAKARALARI / CABLE ROLLER

Künk Agzı Makara Kablo Korumalı / Pipe end with cable protection

Teknik Özellikler / Technical Specifications

Ürün Kodu Product code	Çap Diameter	Agırlık Weight
TBDKAKAK01	50 mm	1,50 Kg
TBDKAKAK02	80 mm	3,00 Kg
TBDKAKAK03	100 mm	4,00 Kg
TBDKAKAK04	120 mm	5,00 Kg
TBDKAKAK05	150 mm	7,00 Kg
TBDKAKAK06	200 mm	9,00 Kg



Künk Agzı Makara Halat Korumalı / Knuckle Mouth Spool Rope Protected

Teknik Özellikler / Technical Specifications

Ürün Kodu Product code	Çap Diameter	Agırlık Weight
TBDKAKAH01	50 mm	2,00 Kg
TBDKAKAH02	80 mm	3,50 Kg
TBDKAKAH03	100 mm	4,50 Kg
TBDKAKAH04	120 mm	5,50 Kg
TBDKAKAH05	150 mm	7,50 Kg
TBDKAKAH06	200 mm	9,50 Kg



Künk Agzı Makara Kilitli / Knuckle mouth with spool lock

Teknik Özellikler / Technical Specifications

Ürün Kodu Product code	Çap Diameter	Agırlık Weight
TBDKAKAH01	50 mm	2,50 Kg
TBDKAKAH02	80 mm	4,00 Kg
TBDKAKAH03	100 mm	5,00 Kg
TBDKAKAH04	120 mm	6,00 Kg
TBDKAKAH05	150 mm	8,00 Kg
TBDKAKAH06	200 mm	10,00 Kg



Künk Agzı Makara Kilitli 4 Silindirli / 4 Cylinder Knuckle Mouth Spool Lock

Teknik Özellikler / Technical Specifications

Ürün Kodu Product code	Çap Diameter	Agırlık Weight
TBDKAKAH01A	50 mm	4,00 Kg
TBDKAKAH02A	80 mm	7,00 Kg
TBDKAKAH03A	100 mm	8,00 Kg
TBDKAKAH04A	120 mm	9,00 Kg
TBDKAKAH05A	150 mm	10,00 Kg
TBDKAKAH06A	200 mm	14,00 Kg



KABLO TAVA MAKARALARI / CABLE TRAY REELS

Düz Tip Kablo Tava Makarası / Flat type cable tray reel

Teknik Özellikler / Technical Specifications

Ürün Kodu / Product code	: TBDKAT01
Taşıma kapasitesi / Capacity	: 750 Kg
Silindir Çapı / Cylinder diameter	: 76 mm
Uzunluk / Length	: 250 mm
Genişlik / Width	: 240 mm
Yükseklik / Height	: 150 mm
Ağırlık / Weight	: 4 Kg



Düz Tip Boru Ayaklı Kablo Tava Makarası / Straight Type Pipe Feet Cable Tray Reel

Teknik Özellikler / Technical Specifications

Ürün Kodu / Product code	: TBDKAT02
Taşıma kapasitesi / Capacity	: 750 Kg
Silindir Çapı / Cylinder diameter	: 76 mm
Uzunluk / Length	: 250 mm
Genişlik / Width	: 240 mm
Yükseklik / Height	: 150 mm
Ağırlık / Weight	: 3,5 Kg



Köşe Tip Kablo Tava Makarası / Corner Cable Tray Reel

Teknik Özellikler / Technical Specifications

Ürün Kodu / Product code	: TBDKAT03
Taşıma kapasitesi / Capacity	: 750 Kg
Silindir Çapı / Cylinder diameter	: 76 mm
Uzunluk / Length	: 200 mm
Genişlik / Width	: 200 mm
Yükseklik / Height	: 160 mm
Ağırlık / Weight	: 4,50 Kg



Köşe Tip Kablo Tava Makarası / Corner Cable Tray Reel

Teknik Özellikler / Technical Specifications

Ürün Kodu / Product code	: TBDKAT04
Taşıma kapasitesi / Capacity	: 750 Kg
Silindir Çapı / Cylinder diameter	: 76 mm
Uzunluk / Length	: 200 mm
Genişlik / Width	: 200 mm
Yükseklik / Height	: 160 mm
Ağırlık / Weight	: 4,50 Kg



KABLO TAVA MAKARALARI / CABLE TRAY REELS

Düz Tip Geçirmeli Kablo Tava Makarası / Straight Type Plug-in Cable Tray Reel

Teknik Özellikler / Technical Specifications

Ürün Kodu / Product code	: TBDKAT05
Taşıma kapasitesi / Capacity	: 500 Kg
Silindir Çapı / Cylinder diameter	: 50 mm
Uzunluk / Length	: 60 mm
Genişlik / Width	: 200 mm
Yükseklik / Height	: 200 mm
Ağırlık / Weight	: 6 Kg



Düz Tip Geçirmeli Kablo Tava Makarası 2'li / Straight Type Plug-in Cable Tray Reel 2x

Teknik Özellikler / Technical Specifications

Ürün Kodu / Product code	: TBDKAT06
Taşıma kapasitesi / Capacity	: 500 Kg
Silindir Çapı / Cylinder diameter	: 50 mm
Uzunluk / Length	: 60 mm
Genişlik / Width	: 400 mm
Yükseklik / Height	: 200 mm
Ağırlık / Weight	: 12 Kg



Düz Tip Geçirmeli Kablo Tava Makarası 3'lü / Straight Type Plug-in Cable Tray Reel 3x

Teknik Özellikler / Technical Specifications

Ürün Kodu / Product code	: TBDKAT07
Taşıma kapasitesi / Capacity	: 500 Kg
Silindir Çapı / Cylinder diameter	: 50 mm
Uzunluk / Length	: 60 mm
Genişlik / Width	: 600 mm
Yükseklik / Height	: 200 mm
Ağırlık / Weight	: 18 Kg



Köşe Tip Geçirmeli Kablo Tava Makarası / Corner Type Plug-in Cable Tray Reel

Teknik Özellikler / Technical Specifications

Ürün Kodu / Product code	: TBDKAT08
Taşıma kapasitesi / Capacity	: 500 Kg
Silindir Çapı / Cylinder diameter	: 50 mm
Uzunluk / Length	: 60 mm
Genişlik / Width	: 250 mm
Yükseklik / Height	: 200 mm
Ağırlık / Weight	: 4 Kg



KABLO TAVA MAKARALARI / CABLE TRAY REELS

Kilitli Kablo Tava Makarası Çok Amaçlı / Lockable Cable Tray Reel Multi-Purpose

Teknik Özellikler / Technical Specifications

Ürün Kodu / Product code	: TBDKAT09
Taşıma kapasitesi / Capacity	: 500 Kg
Silindir Çapı / Cylinder diameter	: 50 mm
Uzunluk / Length	: 60 mm
Genişlik / Width	: 300 mm
Yükseklik / Height	: 300 mm
Ağırlık / Weight	: 16 Kg



Boyu Ayarlanırlı Kablo Tava Makarası / Adjustable Length Cable Tray Reel

Teknik Özellikler / Technical Specifications

Ürün Kodu / Product code	: TBDKAT10
Taşıma kapasitesi / Capacity	: 500 Kg
Silindir Çapı / Cylinder diameter	: 76 mm
Uzunluk / Length	: 300 mm - 600 mm
Genişlik / Width	: 180 mm
Yükseklik / Height	: 120 mm
Ağırlık / Weight	: 14 Kg



Boyu Ayarlanırlı Kablo Tava Makarası 2'li / Adjustable Length Cable Tray Reel 2

Teknik Özellikler / Technical Specifications

Ürün Kodu / Product code	: TBDKAT11
Taşıma kapasitesi / Capacity	: 500 Kg
Silindir Çapı / Cylinder diameter	: 76 mm
Uzunluk / Length	: 300 mm 600 mm
Genişlik / Width	: 1800 mm
Yükseklik / Height	: 300 mm
Ağırlık / Weight	: 16 Kg



Yükseklik Ayarlı Kablo Tava Makarası / Height Adjustable Cable Tray Reel

Teknik Özellikler / Technical Specifications

Ürün Kodu / Product code	: TBDKAT12
Taşıma kapasitesi / Capacity	: 500 Kg
Silindir Çapı / Cylinder diameter	: 76 mm
Uzunluk / Length	: 60 mm
Genişlik / Width	: 150 mm
Yükseklik / Height	: 200 mm 300 mm
Ağırlık / Weight	: 12 Kg



KABLO TAVA MAKARALARI / CABLE TRAY REELS

Kancalı Kablo Atlatma Tava Makarası / Cable Bypass Pan Reel with Hook

Teknik Özellikler / Technical Specifications

Ürün Kodu / Product code	: TBDKAT13
Taşıma kapasitesi / Capacity	: 500 Kg
Silindir Çapı / Cylinder diameter	: 76 mm
Uzunluk / Length	: 300 mm
Genişlik / Width	: 180 mm
Yükseklik / Height	: 400 mm
Ağırlık / Weight	: 16 Kg



Köprü Kablo Tava Makarası / Bridge Cable Tray Reel

Teknik Özellikler / Technical Specifications

Ürün Kodu / Product code	: TBDKAT14
Taşıma kapasitesi / Capacity	: 500 Kg
Silindir Çapı / Cylinder diameter	: 42 mm
Uzunluk / Length	: 400 mm
Genişlik / Width	: 180 mm
Yükseklik / Height	: 250 mm
Ağırlık / Weight	: 14 Kg



Askı Tip Kablo Atlatma Tava Makarası / Suspended Type Cable Jump Tray Reel

Teknik Özellikler / Technical Specifications

Ürün Kodu / Product code	: TBDKAT15
Taşıma kapasitesi / Capacity	: 500 Kg
Silindir Çapı / Cylinder diameter	: 76 mm
Uzunluk / Length	: 800 mm
Genişlik / Width	: 180 mm
Yükseklik / Height	: 300 mm -600 mm
Ağırlık / Weight	: 18 Kg



Yükseklik Ayarlı Kablo Tava Makarası / Height Adjustable Cable Tray Reel

Teknik Özellikler / Technical Specifications

Ürün Kodu / Product code	: TBDKAT16
Taşıma kapasitesi / Capacity	: 500 Kg
Silindir Çapı / Cylinder diameter	: 76 mm
Uzunluk / Length	: 1000 mm
Genişlik / Width	: 150 mm
Yükseklik / Height	: 300 mm 600 mm
Ağırlık / Weight	: 20 Kg



YARDIMCI EKİPMANLAR / AUXILIARY EQUIPMENT

Kablo Çekme Çorapları / Cable Pulling Socks

Teknik Özellikler / Technical Specifications

Ürün Kodu Product code	Çap Diameter	Uzunluk Length	Çekme Tonajı Pull Tonnage
TBDKC5	5-10 mm	900 mm	600 Kg
TBDKC11	11-20 mm	900 mm	1.200 Kg
TBDKC21	21-30 mm	900 mm	1.200 Kg
TBDKC31	31-40 mm	900 mm	1.500 Kg
TBDKC61	61-80 mm	900 mm	2.000 Kg
TBDKC81	81-100 mm	1200 mm	3.000 Kg
TBDKC101	101-120 mm	1200 mm	3.500 Kg
TBDKC121	121-140 mm	1200 mm	4.000 Kg
TBDKC141	141-160 mm	1200 mm	4.500 Kg



Fırdöndüler / Swivels

Ürün Kodu Product code	Çap Diameter	Uzunluk Length	Çekme Tonajı Pull Tonnage
TBDFR5	32 mm	100 mm	500 Kg
TBDFR75	32 mm	100 mm	750 Kg
TBDFR100	32 mm	100 mm	1.000 Kg
TBDFR150	32 mm	100 mm	1.500 Kg
TBDFR200	40 mm	120 mm	2.000 Kg
TBDFR300	40 mm	120 mm	3.000 Kg
TBDFR500	48 mm	130 mm	5.000 Kg
TBDFR1000	48 mm	130 mm	10.000 Kg



İskota Halat / Knitted Yarn

Ürün Kodu Product code	Çap Diameter	Uzunluk Maximum Length Maximum	Çekme Tonajı Pull Tonnage
TBDİH8	8 mm	1000 mm	750 Kg
TBDİH10	10 mm	1000 mm	1000 Kg
TBDİH12	12 mm	1000 mm	1.250 Kg
TBDİH14	14 mm	1000 mm	1.500 Kg
TBDİH16	16 mm	1000 mm	2.000 Kg
TBDİH18	18 mm	1000 mm	3.000 Kg
TBDİH20	20 mm	1000 mm	5.000 Kg



Çelik Halat / Steel Rope

Ürün Kodu Product code	Çap Diameter	Uzunluk Maximum Length Maximum	Çekme Tonajı Pull Tonnage
TBDCH8	8 mm	2000 mm	3000 Kg
TBDCH10	10 mm	2000 mm	5000 Kg
TBDCH12	12 mm	2000 mm	8000 Kg
TBDCH14	14 mm	2000 mm	10000 Kg
TBDCH16	16 mm	2000 mm	15000 Kg



FİBER KILAVUZ ÇUBUĞU / FİBERGLASS DUCK RODDER

18 mm Fiber Kılavuz Çubuğu / 18 mm Fiberglass Duck Rodder

Teknik Özellikler / Technical Specifications

Ürün Kodu Product code	Çap Diameter	Uzunluk Length
TBDFK1801	18 mm	50 mt
TBDFK1802	18 mm	100 mt
TBDFK1803	18 mm	120 mt
TBDFK1804	18 mm	150 mt
TBDFK1805	18 mm	200 mt
TBDFK1806	18 mm	250 mt
TBDFK1807	18 mm	300 mt



16 mm Fiber Kılavuz Çubuğu / 16 mm Fiberglass Duck Rodder

Teknik Özellikler / Technical Specifications

Ürün Kodu Product code	Çap Diameter	Uzunluk Length
TBDFK1601	16 mm	50 mt
TBDFK1602	16 mm	100 mt
TBDFK1603	16 mm	120 mt
TBDFK1604	16 mm	150 mt
TBDFK1605	16 mm	200 mt
TBDFK1606	16 mm	250 mt
TBDFK1607	16 mm	300 mt



14 mm Fiber Kılavuz Çubuğu / 14 mm Fiberglass Duck Rodder

Teknik Özellikler / Technical Specifications

Ürün Kodu Product code	Çap Diameter	Uzunluk Length
TBDFK1401	14 mm	50 mt
TBDFK1402	14 mm	100 mt
TBDFK1403	14 mm	120 mt
TBDFK1404	14 mm	150 mt
TBDFK1405	14 mm	200 mt
TBDFK1406	14 mm	250 mt
TBDFK1407	14 mm	300 mt



12 mm Fiber Kılavuz Çubuğu / 12 mm Fiberglass Duck Rodder

Teknik Özellikler / Technical Specifications

Ürün Kodu Product code	Çap Diameter	Uzunluk Length
TBDFK1201	12 mm	50 mt
TBDFK1202	12 mm	100 mt
TBDFK1203	12 mm	120 mt
TBDFK1204	12 mm	150 mt
TBDFK1205	12 mm	200 mt
TBDFK1206	12 mm	250 mt
TBDFK1207	12 mm	300 mt



FİBER KILAVUZ ÇUBUĞU / FİBERGLASS DUCK RODDER

11 mm Fiber Kılavuz Çubuğu / 11 mm Fiberglass Duck Rodder

Teknik Özellikler / Technical Specifications

Ürün Kodu Product code	Çap Diameter	Uzunluk Length
TBDFK1101	11 mm	50 mt
TBDFK1102	11 mm	100 mt
TBDFK1103	11 mm	120 mt
TBDFK1104	11 mm	150 mt
TBDFK1105	11 mm	200 mt
TBDFK1106	11 mm	250 mt
TBDFK1107	11 mm	300 mt



10 mm Fiber Kılavuz Çubuğu / 10 mm Fiberglass Duck Rodder

Teknik Özellikler / Technical Specifications

Ürün Kodu Product code	Çap Diameter	Uzunluk Length
TBDFK1001	10 mm	50 mt
TBDFK1002	10 mm	100 mt
TBDFK1003	10 mm	120 mt
TBDFK1004	10 mm	150 mt
TBDFK1005	10 mm	200 mt
TBDFK1006	10 mm	250 mt
TBDFK1007	10 mm	300 mt



9 mm Fiber Kılavuz Çubuğu / 9 mm Fiberglass Duck Rodder

Teknik Özellikler / Technical Specifications

Ürün Kodu Product code	Çap Diameter	Uzunluk Length
TBDFK0901	9 mm	50 mt
TBDFK0902	9 mm	100 mt
TBDFK0903	9 mm	120 mt
TBDFK0904	9 mm	150 mt
TBDFK0905	9 mm	200 mt
TBDFK0906	9 mm	250 mt
TBDFK0907	9 mm	300 mt



8 mm Fiber Kılavuz Çubuğu / 8 mm Fiberglass Duck Rodder

Teknik Özellikler / Technical Specifications

Ürün Kodu Product code	Çap Diameter	Uzunluk Length
TBDFK0801	8 mm	50 mt
TBDFK0802	8 mm	100 mt
TBDFK0803	8 mm	120 mt
TBDFK0804	8 mm	150 mt
TBDFK0805	8 mm	200 mt
TBDFK0806	8 mm	250 mt
TBDFK0807	8 mm	300 mt



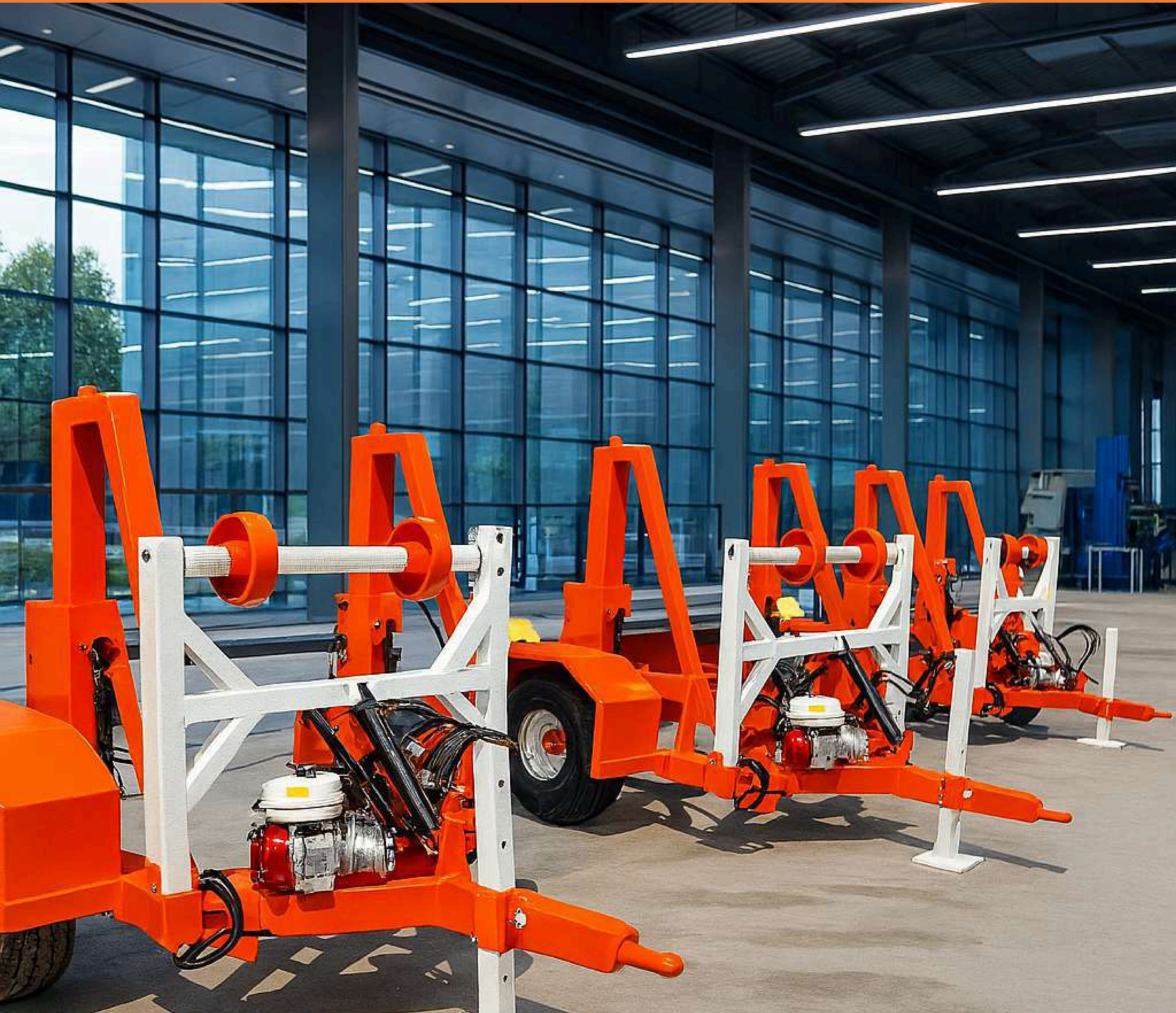

Contact us now!



(+90) 312 870 1772



(+90) 543 578 7323



sales@globalcablecenter.com



www.globalcablecenter.com



@globalcablecenter



GlobalCableCenter

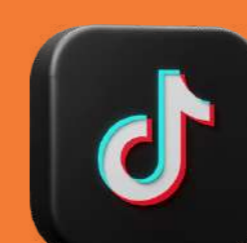

@gccglobalcablecenter